

AIR TORQUE HEAVY DUTY AT-HD Series

Scotch Yoke Actuators

"fully made in Italy"

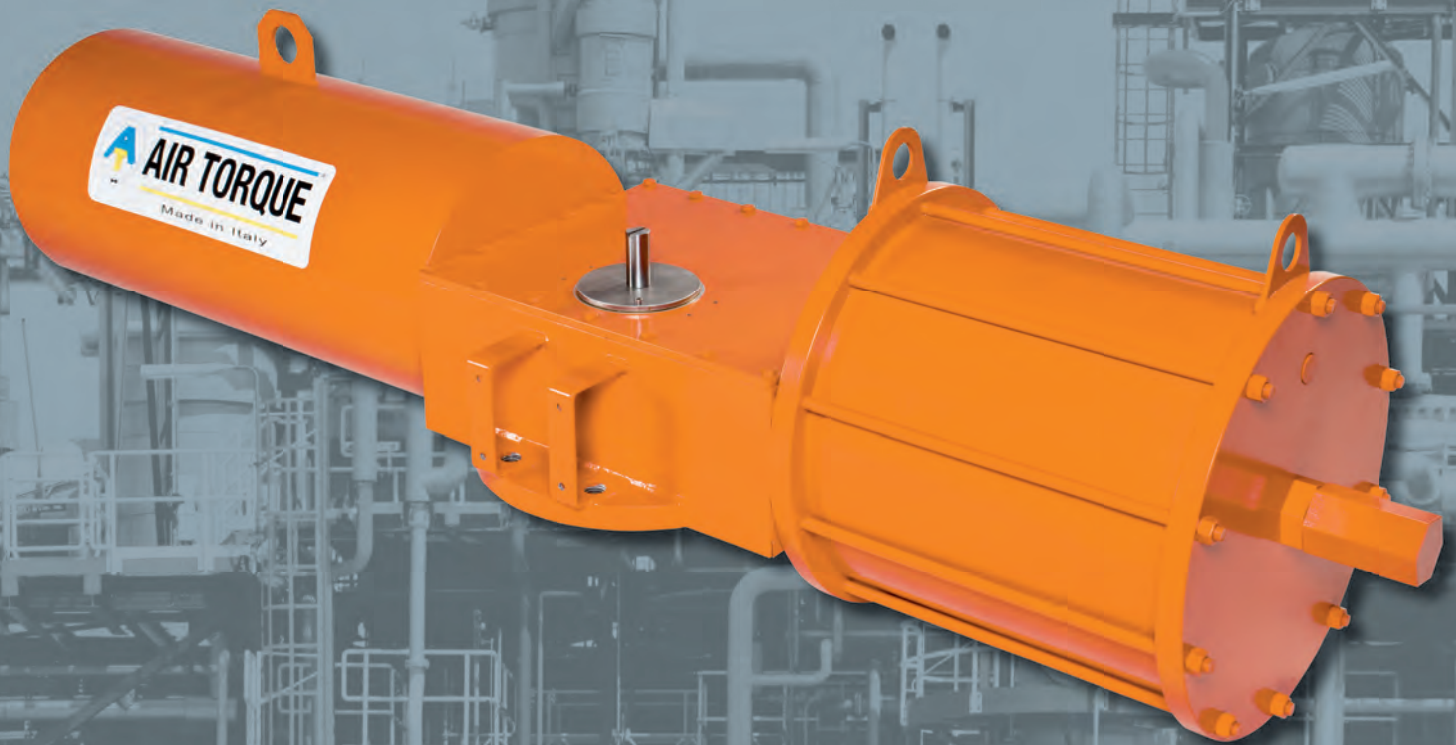

The results of the long
experience in design



AIR TORQUE[®]



The COMPANY

With over 20 years of experience in engineering and manufacturing of rack and pinion actuators, the Air Torque brand is well recognized worldwide and make us the perfect choice for reliable valve automation. Thanks to a combination of long field experience, innovative spirit, well know reliability and high quality manufacturing level granted by western Europe components suppliers, Air Torque SpA is a global leader in valve actuation technology.

We have thousands actuators installation in chemical, petrochemical, pharmaceutical, power generation, pulp and paper, water treatment, food and beverage, oil and gas industries since all of customers rely in our products, in our level of service and in our people. With the continuous care to the customer needs, today as in the past, Air Torque SpA develops products with high level of innovation.



AT-HD HEAVY DUTY ACTUATORS SERIES

The AT-HD Heavy Duty Actuator Series is a clear result of the Air Torque SpA innovation process. The new series is the extension of the Air Torque product range. The frequent requests of our customers for actuators able to provide higher torques and a long cooperation with some End-Users who trust in our reliability and quality have encouraged the AT-HD creation.

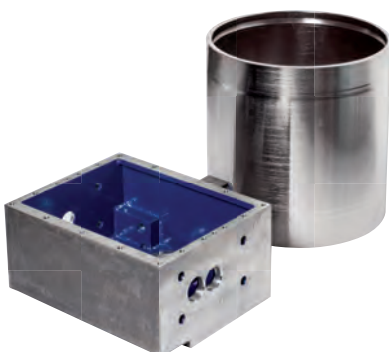

Based on Scotch Yoke design, the AT-HD actuators incorporate engineering excellences, high quality, materials and production process at the state of the art so that to represent a robust solution for integrated valve automation for project-specific customer requirements.

The AT-HD scotch yoke actuators are designed to operate ball valve, butterfly valve and plug valves. On/Off and modulating duty are possible with the AT-HD Series rotary/quarter turn actuators.



Strong Design for heavy duties

The AT-HD series is designed and fully tested in Air Torque facilities. Special technical features and high grade materials are integrated in this product line to perfectly resist to the heavy duties working conditions.

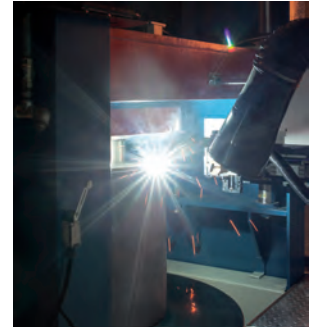
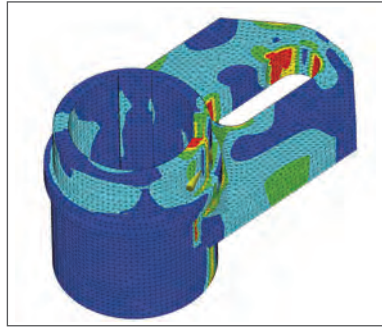

Testing in House

Thanks to the recognized know-how, reliability and strong experience in valve automation, Air Torque performs in house all the committed tests in order to guarantee the compliance with the technical specification and more in general the quality and the reliability of the AT-HD actuators.



Main FEATURES

Pneumatic working pressure: **up to 10 bar (150 psi)** (for std actuators) – higher pressure on request

Hydraulic working pressure: **up to 210 bar (3000 psi)**

Output torque for double acting configuration up to 60.000 Nm (535.000 lbs/in)

Output torque for spring return configuration over 30.000 Nm (270.000 lbs/in)

Working temperature ranges:

S (standard working temp): **-40°C to +80°C**
(-40°F to +176°F)

H (high working temp): **-15°C to +150°C**
(+5°F to +302°F)

L (low working temp) with special execution

■ Symmetric and canted yoke

The scotch and yoke mechanism is available both in symmetric and in canted design.

The valve torque demand can be better followed with consequent cost efficiency and smallest size selection at the lightest actuator weight.

SYMMETRIC YOKE

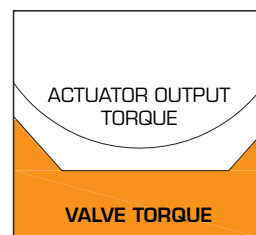

0° ROTATION 90°

CANTED YOKE

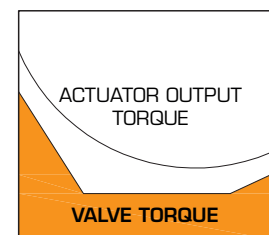

0° ROTATION 90°

■ Versatility

Air Torque AT - HD actuator series is based on modular design. This feature allows high rate of production flexibility. Compliance with customers actuator construction requests are easily achievable in a reasonable time.

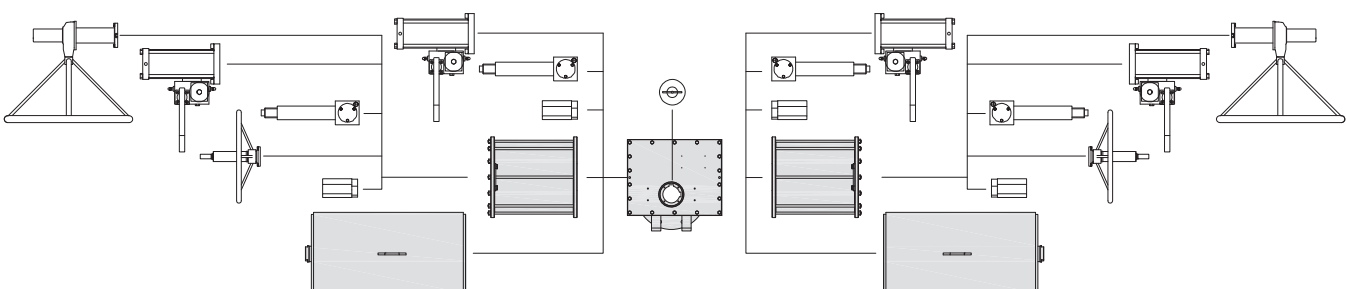

Pneumatic power module options

Together with the most popular scotch yoke design with external tie rods for the pneumatic power module, Air Torque SpA developed a **new design without tie rods**.

- cleaner design coating
- more even coating
- less tie rod elongation trouble under temperature variations
- easy coating maintenance
- easier painting process

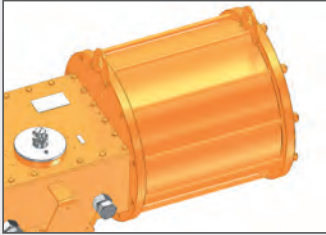

Cylinder with tie rods

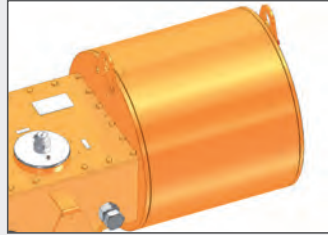

Cylinder without tie rods

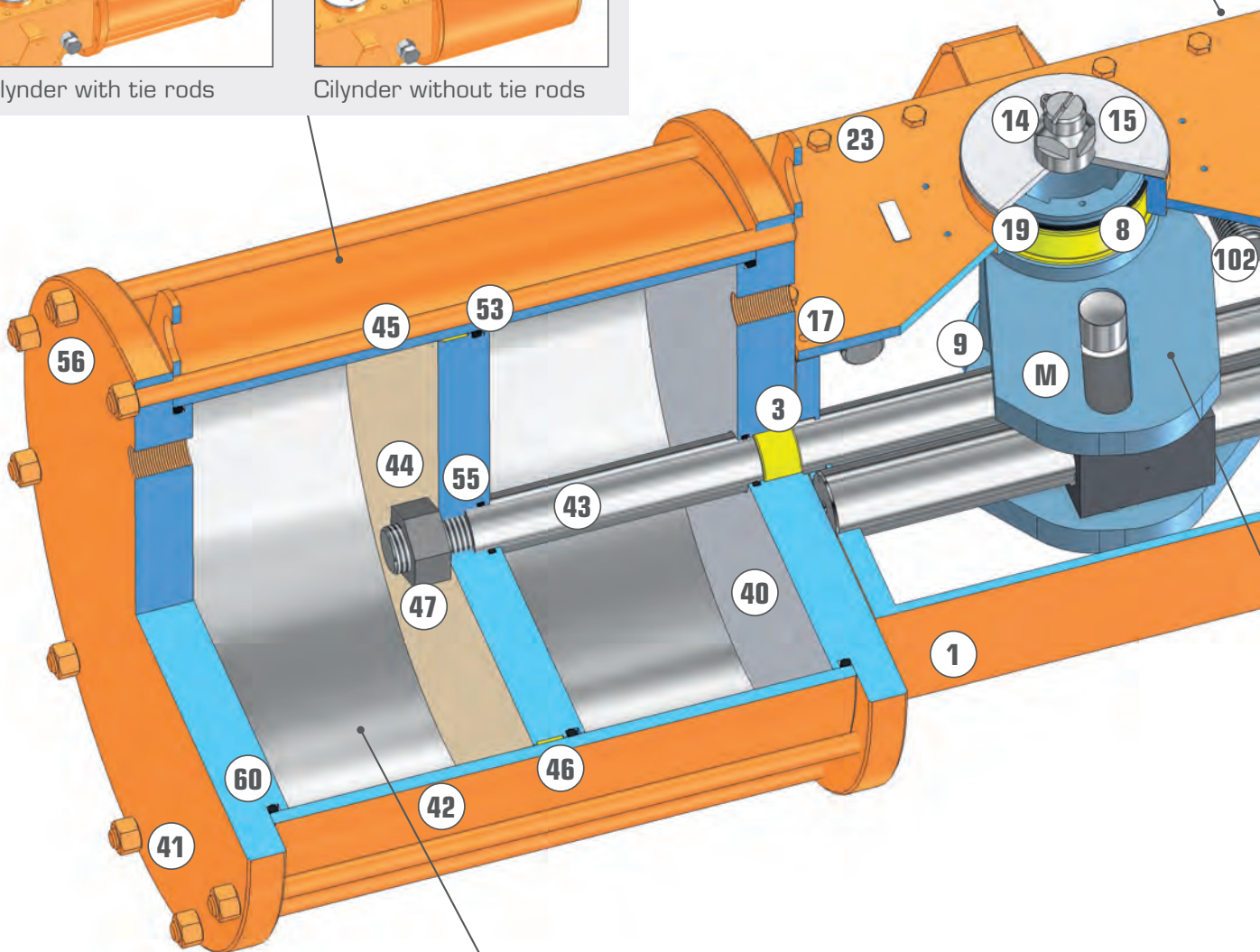

Frontal adjustment screws

The stroke adjustment is possible through **screws located in the frontal area** of the AT-HD actuators.

- simpler stroke adjustment
- shorter actuator
- less extended area of potential corrosion

Corrosion protection

The AT-HD Actuator Series is weather proof. **The actuator shaft is always supplied with coating**, following the Air Torque habit to take care of any detail and to grant the maximum protection level possible. This is a feature which makes the AT-HD unique. High corrosion resistance materials, together with the coating of the internal components, improve the attitude to long resistance against the corrosion. AT-HD 3 layers min. standard coating. Other coatings available under request

Safe Design

The **spring module is supplied completely welded and sealed**. The spring module can be removed from the central module (only with spring completely relaxed).

- no potential injuries due to accidental spring release during actuator installation and maintenance
- spring modules interchangeability

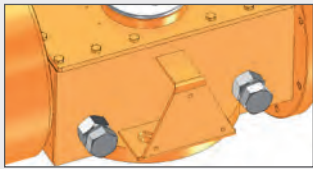

Rotation and stroke adjustment

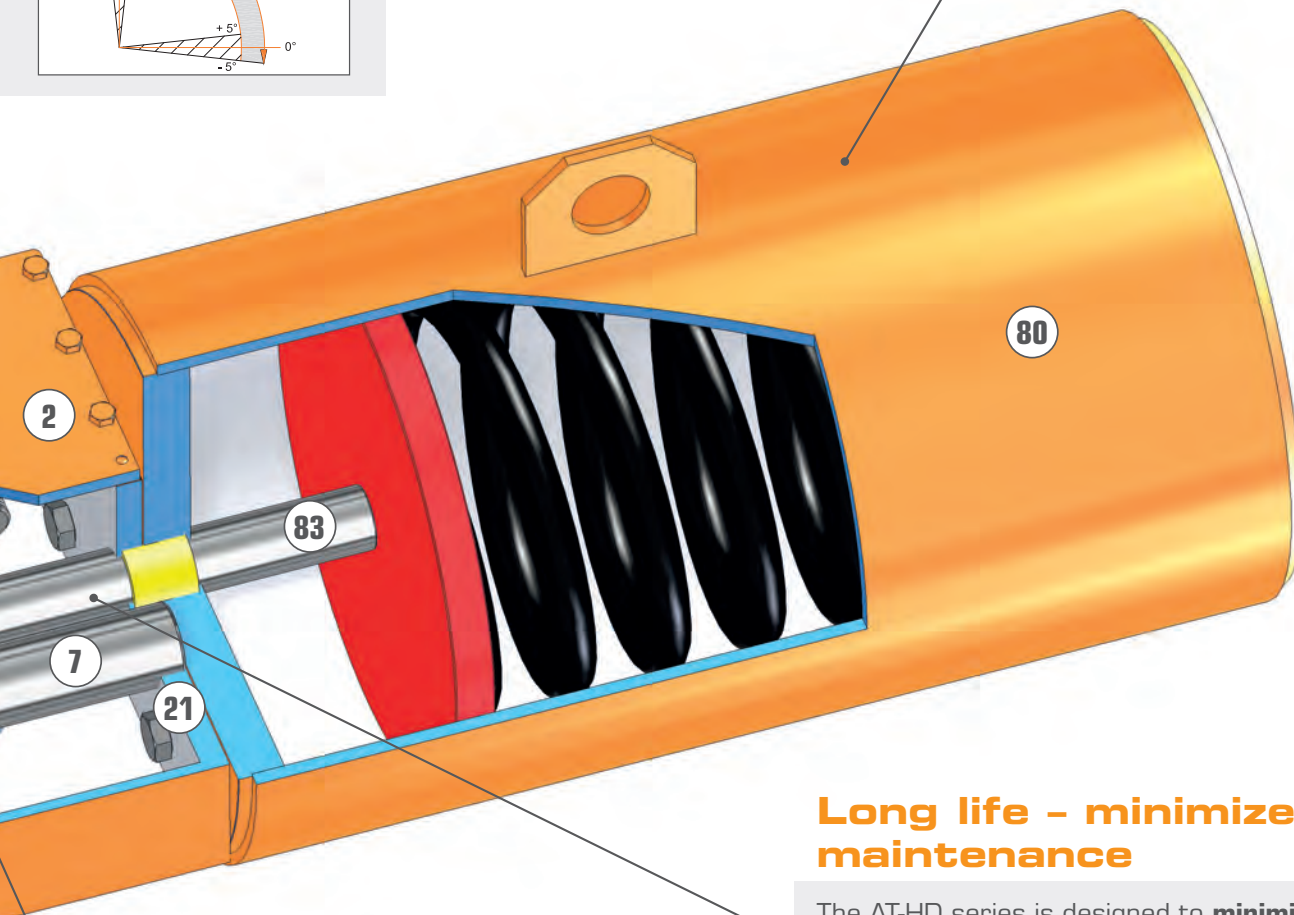
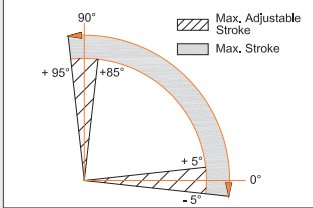

Greased for life

The special design of the scotch yoke mechanism in combination with a special grease selection permits a long grease retention and long lubrication benefits.

Long life - minimized maintenance

The AT-HD series is designed to **minimize the maintenance frequency and so to provide long and efficient service**.

- innovative and special concepts
- innovative materials and surface treatments
- extended the lifespan
- High frequency cycle service is really granted

PART N°	DESCRIPTION	MATERIALE OP. TEMP. STANDARD "S"
M	Mechanism unit	High Alloy Steel
1	Housing (central module)	Carbon Steel
2	Cover (central module)	Carbon Steel
3	Centering bush	Carbon Steel
7	Guide bar	42CrMo4
8	Upper bearing (scotch yoke)	High Grade Polymer
9	Lower bearing (scotch yoke)	High Grade Polymer
14	Extension (position indicator)	S.S.
15	Washer (position indicator)	S.S.
17	Pin (cover)	Alloy Steel
19*	O-ring (shaft)	M-NBR
21	Hex. Screw (module connection)	S.S.
23	Hex. Screw (cover)	S.S.
40	Head flange (power module)	Carbon Steel

PART N°	DESCRIPTION	MATERIALE OP. TEMP. STANDARD "S"
41	End flange (power module)	Carbon Steel
42	Power cylinder	Carbon Steel
43	Piston shaft	42CrMo4
44	Piston	Carbon Steel
45	Tie rod	Carbon Steel
46*	Bearing (piston)	PTFE+GRAPHITE
47	Nut (piston shaft)	Carbon Steel
53*	O-ring (piston)	M-NBR
55*	O-ring (piston shaft)	M-NBR
56	Nut (tie rod)	Carbon Steel
60*	O-ring (flange)	M-NBR
80	Spring cylinder	Carbon Steel
83	Shaft (spring)	42CrMo4
102	Stop cap screw (central travel stop adj.)	S.S.

For complete part list refer to related data sheets.

OPERATING FUNCTION SCHEME

DOUBLE ACTING PNEUMATIC ACTUATOR - CLOCKWISE CLOSING ROTATION (top view)

Air supplied to port 2 forces the piston toward the central module. A counter clockwise rotation is achieved. Exhaust air flows through the port 4.

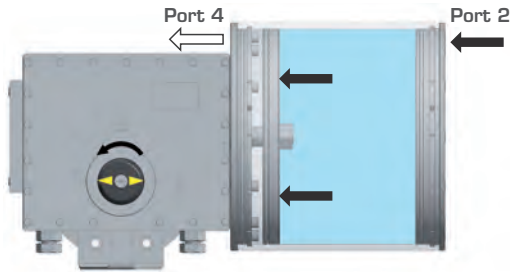

Air supplied to port 4 forces the piston far from the central module toward the end of the power module. A clockwise rotation is achieved. Exhaust air flows from the port 2.

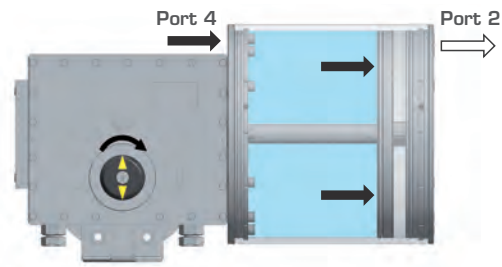

SPRING RETURN PNEUMATIC ACTUATOR - CLOCKWISE CLOSING ROTATION (top view)

Air supplied to port 2 forces the piston toward the central module, compressing the spring. A counter clockwise rotation is achieved. Exhaust air flows from port 4.

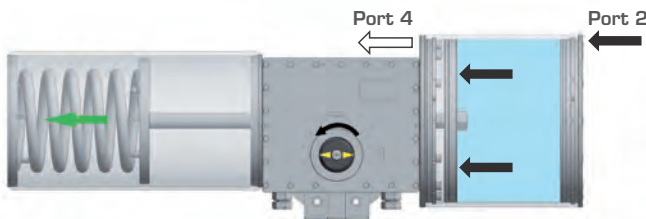

The depressurization to the port 2 (due to air supply cut or electricity cut) allows the spring to move the piston far from the central module/toward the end of the power module. A clockwise rotation is achieved. Exhaust air flows from port 2.

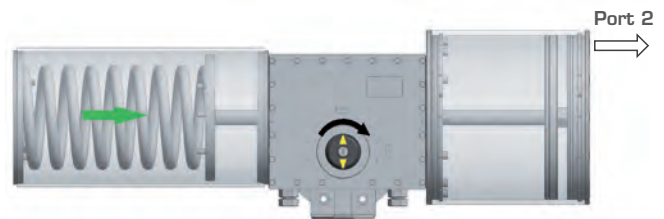

Available options for emergency operations

A wide range of options is available for emergency operations. Manual overrides are an important options for valve automation. Air Torque is able to define and supply different kind of override in order to meet the customers request in the best way. Jack screw, hand pump, gear are available.

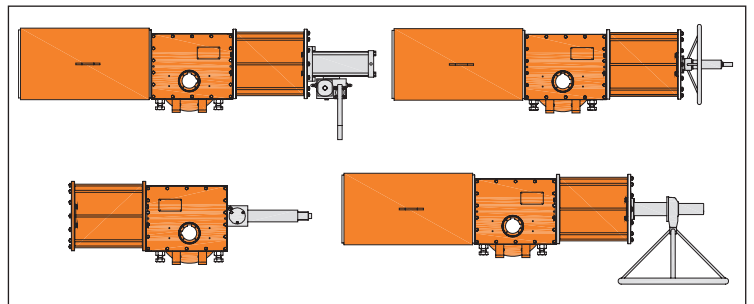

Control system

Control panels and control systems packages is an added value Air Torque can offer. With his long field experience in valve automation we are able to satisfy almost all the customers requirements.

The applications of our control system are many and many, from Emergency shutdown (ESD) to partial stroke (PST), from quick operation to fieldbus modulating duties.



CERTIFICATION: CE, PED available on request, ATEX, TC RU C (Certificate of Conformity)

STANDARD COMPLIANCE: EN 15714-3, EN 15714-4, ISO 5211

HOW TO ORDER

AVAILABLE OPTIONS AND ORDERING CODES:

1	ACTUATOR MODELS	Heavy Duty Actuator AIR TORQUE 90° Rotation AT-HD1 = for models with lever arm up to 065 mm excluding AT-HD = for models with lever arm from 065 mm including and bigger	9	ACTUATOR	OO = Without Indicator O1 = Standard Indicator
2	TRAVEL STOP POSITION	C = Central Travel Stop O = External Travel	10	SUPPLY MEDIUM	P = Pneumatic H = Hydraulic G = Gas
3	ACTUATOR BODY SIZE (LEVER ARM DIMENSIONS in mm)	... 065 - 085 - 100 - 130 - 160 - 200 ...	11	POWER CYLINDER SIZE (in mm)	Pneumatic/Gas: from 180mm up to 1300mm Hydraulic: from 40mm up to 300mm
4	YOKE TYPE	S = Symmetric C = Canted	12	POWER MODULE TYPE	O = Standard (without tie rods) 1 = With tie rod
5	ACTION	D = Double Acting DD = Double-Double Acting SC = Spring Return / Fail to CLOSE SO = Spring Return / Fail to OPEN	13	OPERATING TEMPERATURE	S = Standard -40°C ÷ +80°C H = High Temperature -15°C ÷ +150°C L = Low temperature below -40°C (available with special execution)
6	SPRING MODULE	from model O1 up to model 20 (see output torque data) ONLY FOR SPRING RETURN ACTUATORS	14	SUPPLY CONNECTION SIZE	1/4" GAS up to 1" GAS 1/4" NPT up to 1" NPT
7	VALVE ISO FLANGE 5211	up to F48	15	MANUAL OVERRIDE TYPE	Blank = Standard Without Manual Override J = Jackscrew H = Hydraulic Pump D = Gear
8	DRIVE CONNECTIONS	STANDARD: Double Key dimensions Other connections available on request	16	ACTUATOR COATING	Blank = Standard XXX = Other coating to be specified on request

All dimensions and materials are referred to updated catalogue and/or technical data sheet.

HOW TO ORDER: EXAMPLES

1	2	3	4	5	6	7	8	9	10	11	12	13	14	15	16
AT-HD	C	085	S	SC	20	F16	D72X20	O1	P	285	O	S	G1/2"	/	/

Detailed dimensions and technical data are available under request.



AIR TORQUE[®]



HEAD OFFICE AND WORKS



AIR TORQUE S.P.A.

Head Offices: Via dei Livelli di Sopra, 11
Factory: Via dei Livelli di Sopra, 8
24060 COSTA DI MEZZATE (Bergamo) ITALY
Tel. +39 035 682299 - Fax +39 035 687791
www.airtorque.it - e-mail: info@airtorque.it